

A wooden play structure with a blue net and swings in a grassy area. The structure is made of light-colored wood and has a blue net hanging from it. There are also two swings hanging from the structure. The background shows a fence and trees.

play in
motion

The logo for Active Garden. The word 'Active' is in green and 'Garden' is in blue. A red line starts from the top of the 'A' in 'Active', loops around the 'G' in 'Garden', and ends at the top of the 'A' in 'Active'.

**Active
Garden**

**Play Equipment and
Safety Surface**

Contact us:

T: 01568 782241

E: info@activegarden.co.uk

www.activegarden.co.uk

2.0m - 1 Cradle Seat

L: 2610 W:1424 2138mm
 Min Surface Area: 6.05 x 1.75m (10.6m²)
 Min Space: 6.05 x 2.61m FFH: 1.2m

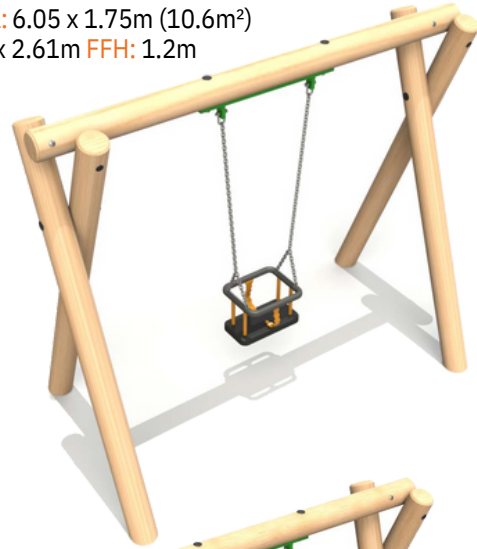

2.4m - 1 Flat Seat

L: 2610 W:1730 2538mm
 Min Surface Area: 6.7 x 1.75m (11.7m²)
 Min Space: 6.7 x 2.61m FFH: 1.4m

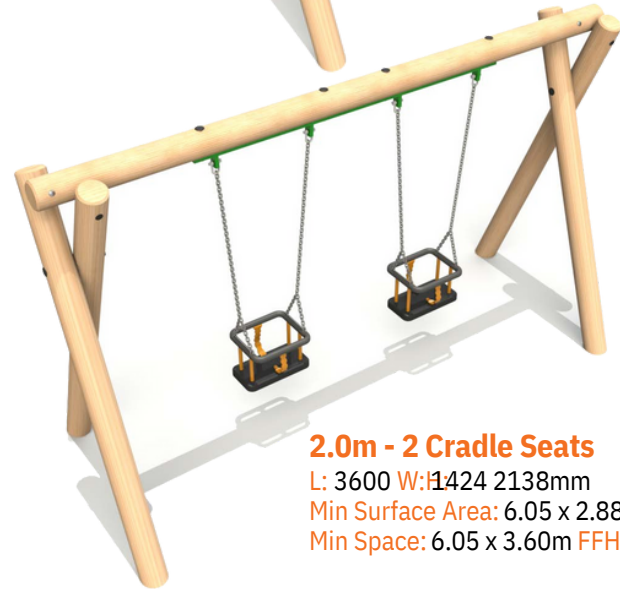

2.0m - 2 Cradle Seats

L: 3600 W:1424 2138mm
 Min Surface Area: 6.05 x 2.88m (17.4m²)
 Min Space: 6.05 x 3.60m FFH: 1.2m



2.4m - 2 Flat Seats

L: 3600 W:1730 2538mm
 Min Surface Area: 6.7 x 2.88m (19.3m²)
 Min Space: 6.7 x 3.60m FFH: 1.4m

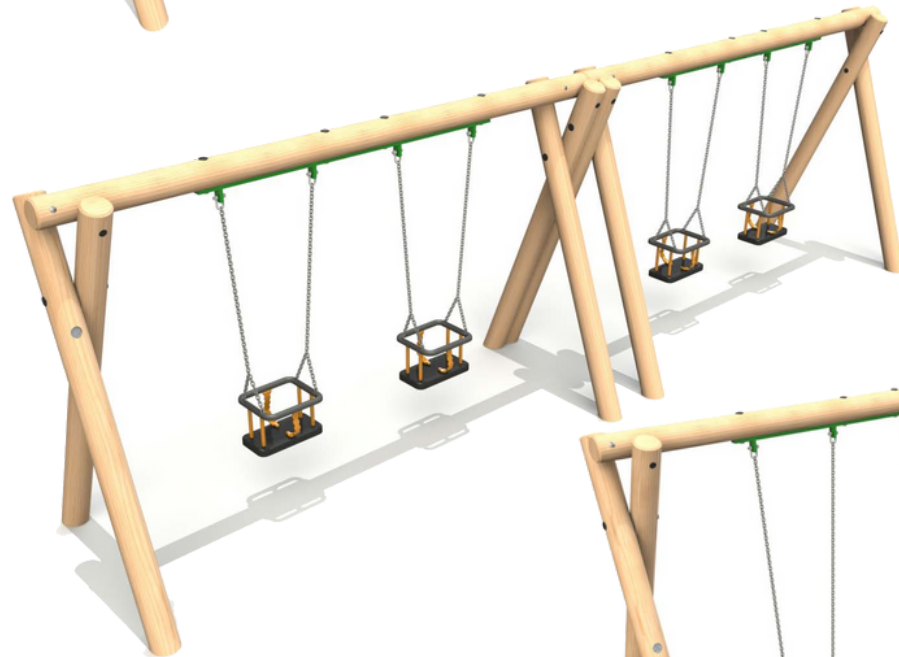

2.0m - 4 Cradle Seats

L: 7200 W:1424 2138mm
 Min Surface Area: 6.05 x 5.76m (34.8m²)
 Min Space: 7.2 x 6.05m FFH: 1.2m

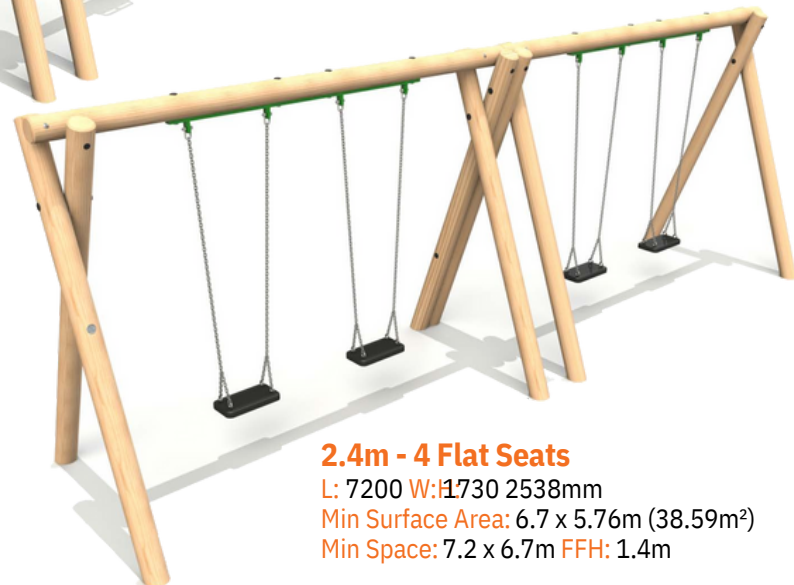

2.4m - 4 Flat Seats

L: 7200 W:1730 2538mm
 Min Surface Area: 6.7 x 5.76m (38.59m²)
 Min Space: 7.2 x 6.7m FFH: 1.4m

Steel Feet options Available, more details and prices are available upon request

2.4m - 2 Flat & 1 Cradle Seats

L: 6210 W:1730 2538mm
 Min Surface Area: 6.7 x 4.63m (31.02m²)
 Min Space: 6.7 x 6.2m FFH: 1.4m

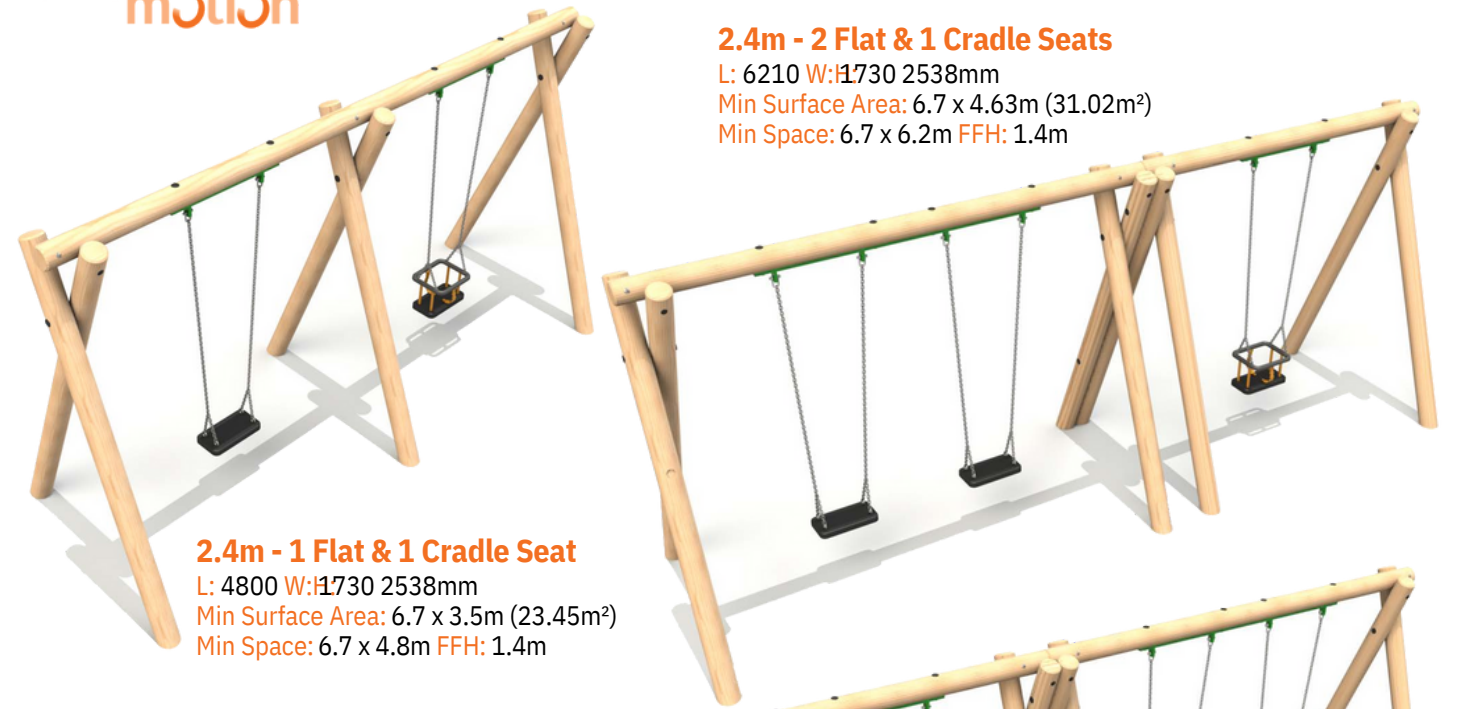

2.4m - 1 Flat & 1 Cradle Seat

L: 4800 W:1730 2538mm
 Min Surface Area: 6.7 x 3.5m (23.45m²)
 Min Space: 6.7 x 4.8m FFH: 1.4m



2.4m - 1 Inclusive Seat

L: 2742 W:1730 2538mm
 Min Surface Area: 7 x 1.8m (12.6m²)
 Min Space: 7 x 2.61m FFH: 1.4m

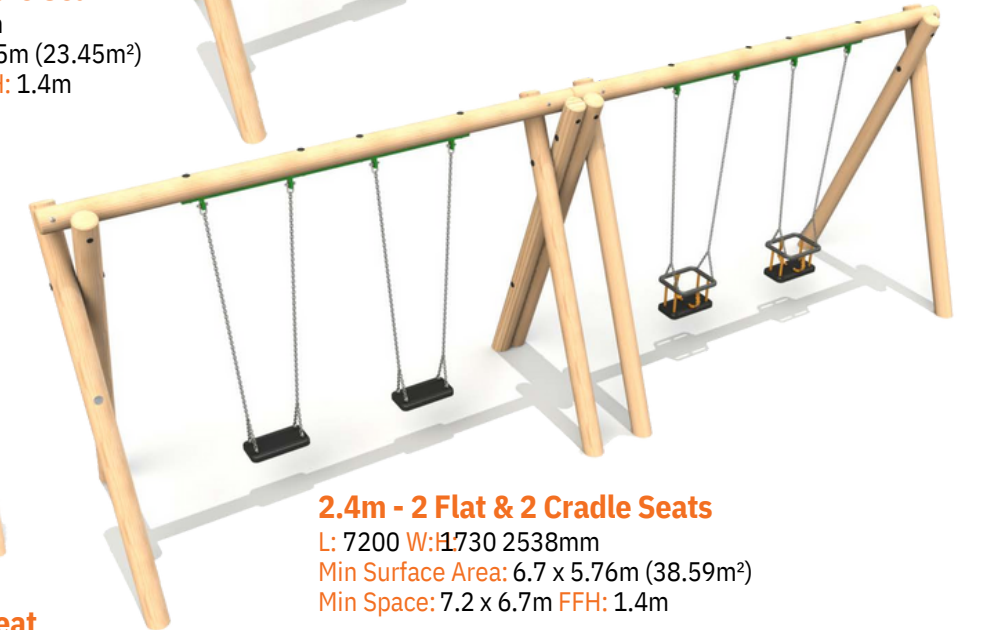

2.4m - 2 Flat & 2 Cradle Seats

L: 7200 W:1730 2538mm
 Min Surface Area: 6.7 x 5.76m (38.59m²)
 Min Space: 7.2 x 6.7m FFH: 1.4m



2.4m - 1 Inclusive & 1 Cradle Seat

L: 3600 W:1730 2538mm
 Min Surface Area: 7 x 2.93m (20.51m²)
 Min Space: 7 x 3.60m FFH: 1.4m



2.4m - 1 Inclusive & 1 Flat Seat

L: 3600 W:1730 2538mm
 Min Surface Area: 7 x 2.93m (20.51m²)
 Min Space: 7 x 3.60m FFH: 1.4m



Steel feet

Galvanised steel feet can be fitted on all timber swings for a small additional charge. Steel feet offer an alternative to in-ground timbers and can be used in both wet pour and extended for loose fill surfacing.

Steel Feet options Available, more details and prices are available upon request

2.4m Timber Group Swing
 L: 3600 W:H1730 2538mm
 Min Surface Area: 7 x 3m (21m²)
 Min Space: 7 x 3.60m FFH: 1.4m

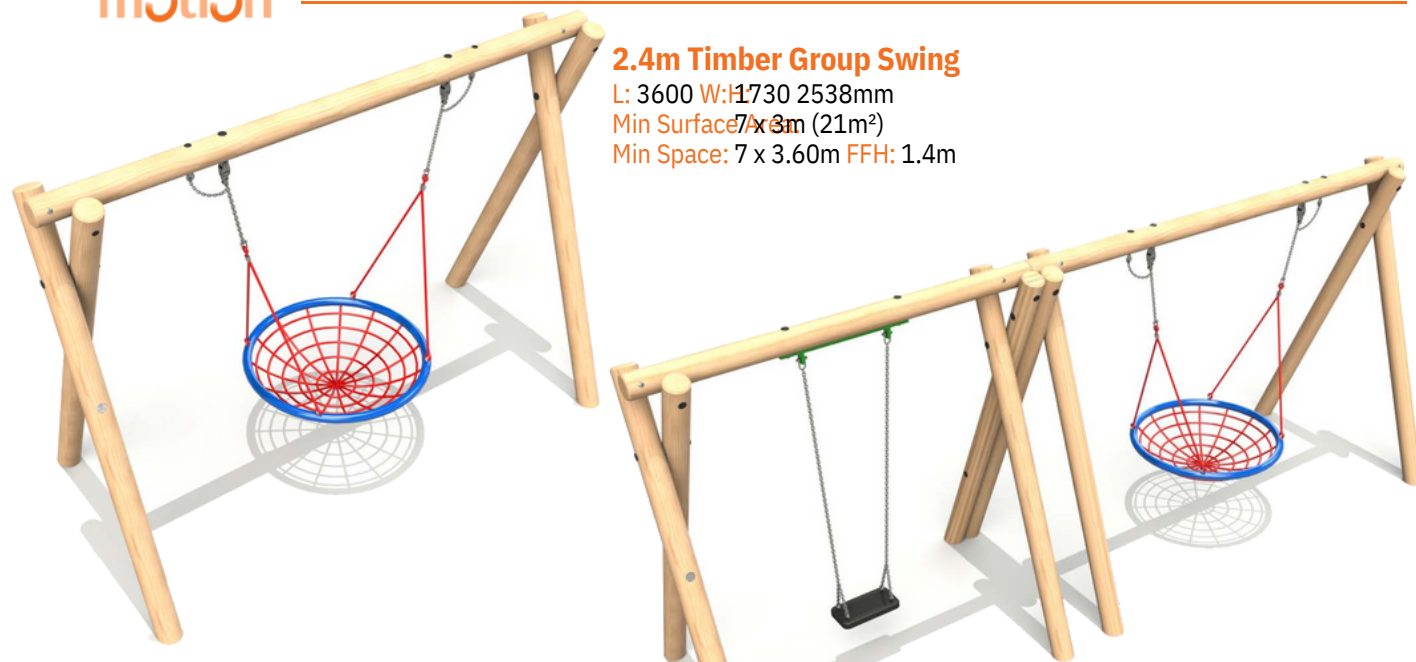

2.4m - 1 Flat & 1 Group Seat
 L: 6210 W:H1730 2538mm
 Min Surface Area: 7 x 5m (35m²)
 Min Space: 6.22 x 7m FFH: 1.4m

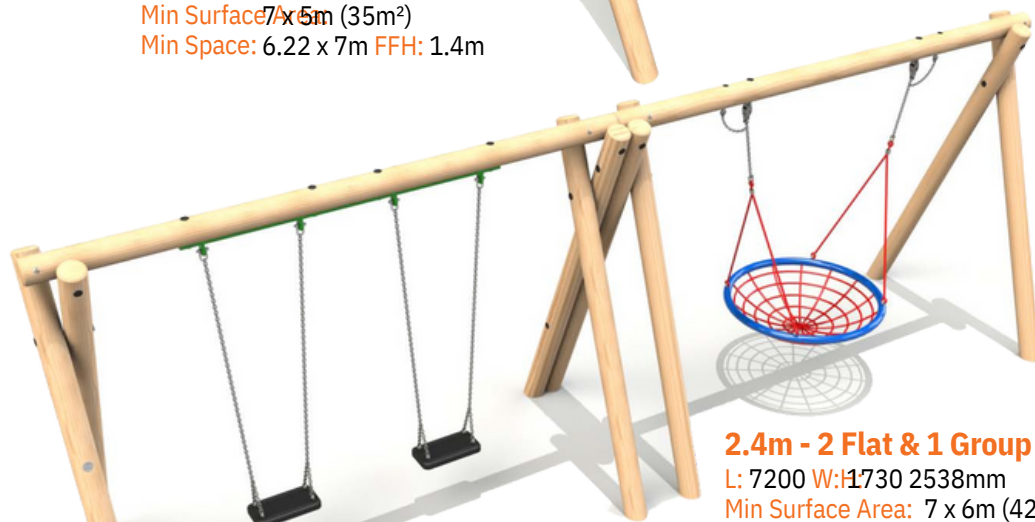

2.4m - 2 Flat & 1 Group Seat
 L: 7200 W:H1730 2538mm
 Min Surface Area: 7 x 6m (42m²)
 Min Space: 7.2 x 7m FFH: 1.4m



Timber Swing Frames available without seats and chains. Frames come with all fixings and swing seat hangers. Universal joints and safety chains are not included with the group seat frames.

Steel Feet options Available, more details and prices are available upon request

Six Seat Hexagonal Swing
 L: 7040 W:H139 2620mm
 Min Surface Area: 12.6 x 11.8m (58.3m²)
 Min Space: 13.12 x 12.24m FFH: 1.4m

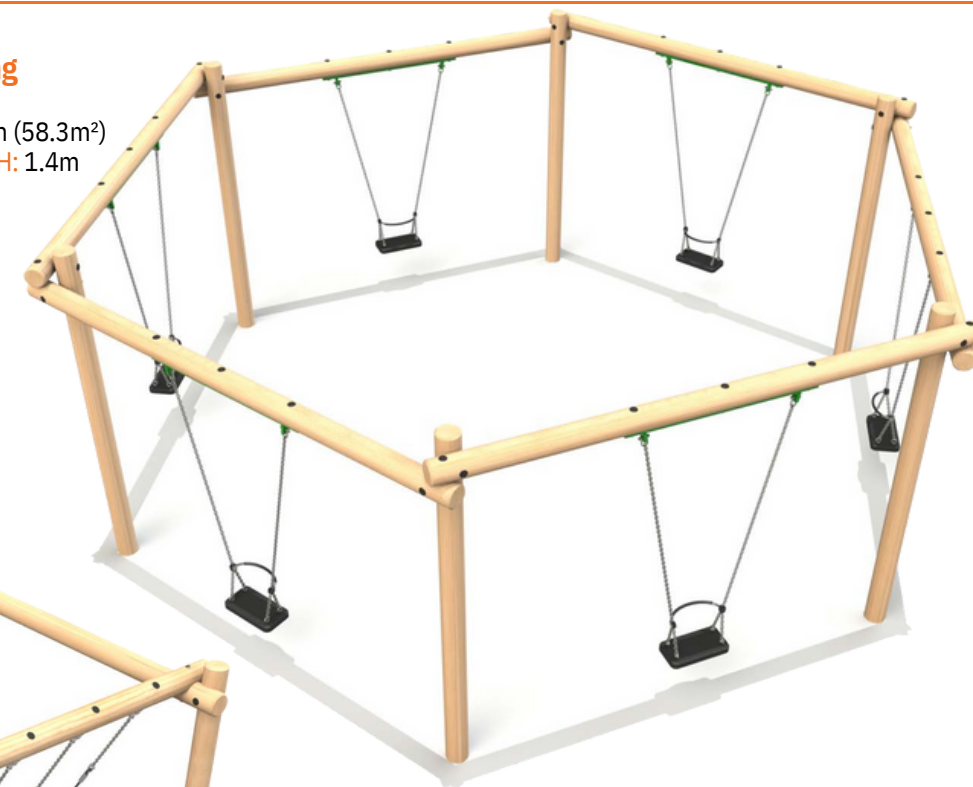

2.35m Crocodile Swing
 L: 3000 W:H2800 2820mm
 Min Surface Area: 8.53 x 3.2m (25.2m²)
 18.53 x 3.15m FFH: 1.5m
 Includes steel feet as standard

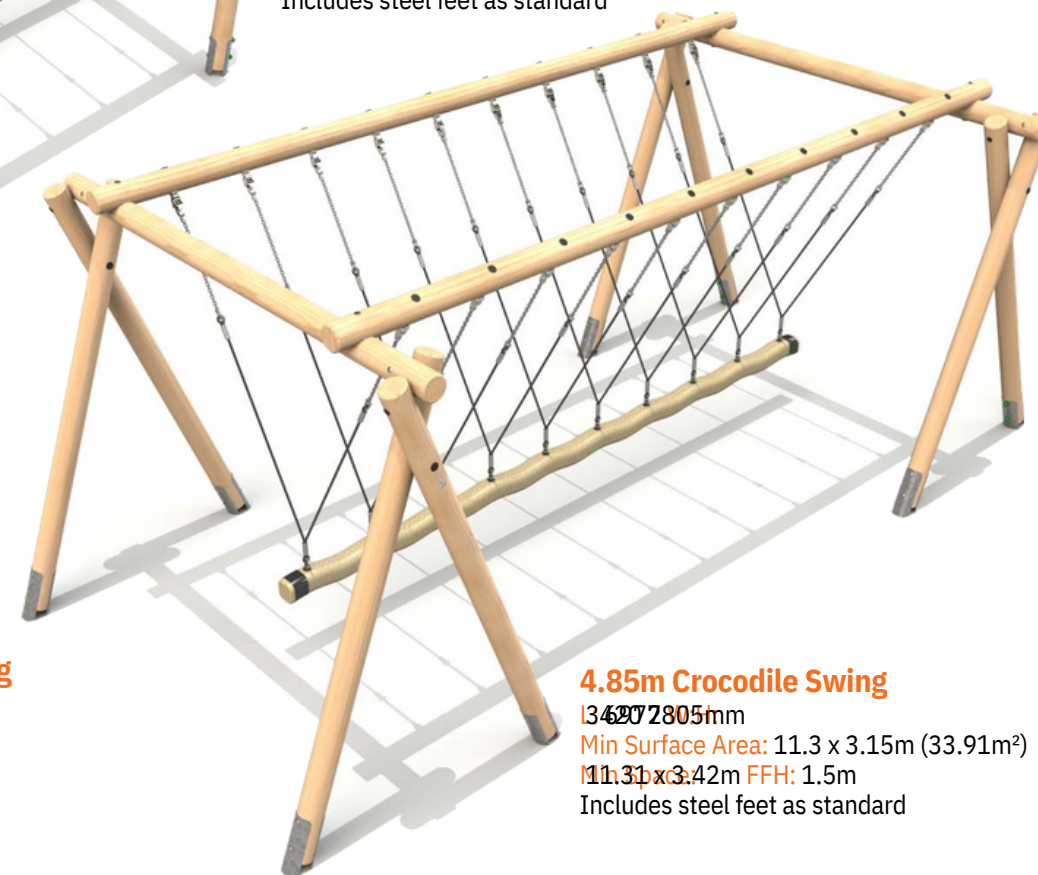
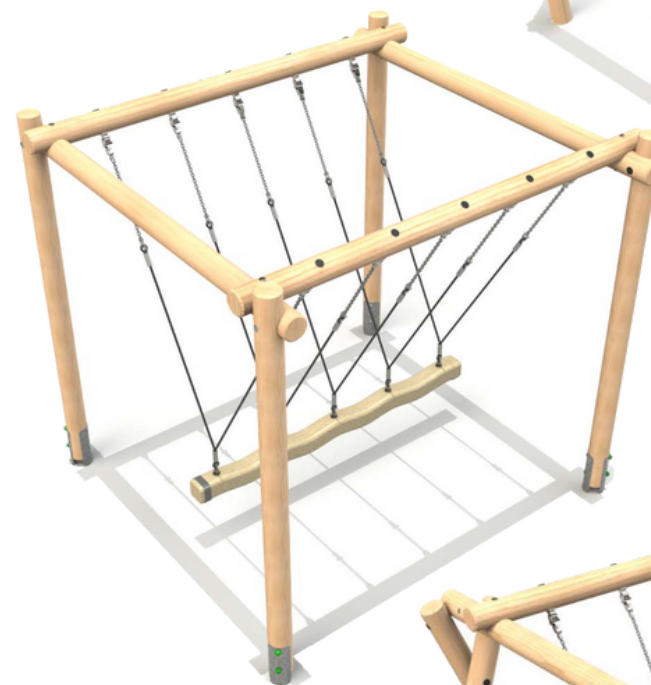

3.35m Crocodile Swing
 also available

4.85m Crocodile Swing
 L: 4850 W:H2805mm
 Min Surface Area: 11.3 x 3.15m (33.91m²)
 11.31 x 3.42m FFH: 1.5m
 Includes steel feet as standard



Steel feet

Galvanised steel feet can be fitted on all timber swings for a small additional charge. Steel feet offer an alternative to in-ground timbers and can be used in both wet pour and extended for loose fill surfacing.

Steel Feet options Available, more details and prices are available upon request

2.0m - 1 Cradle Seat

L: 2660 W:1150 H:2110mm
 Min Surface Area: 6.05 x 1.75m (10.6m²)
 Min Space: 6.05 x 2.66m FFH: 1.2m



2.4m - 1 Flat Seat

L: 2820 W:1300 H:2510mm
 Min Surface Area: 6.7 x 1.75m (11.72m²)
 Min Space: 6.7 x 2.82m FFH: 1.4m



2.0m - 2 Cradle Seats

L: 3780 W:1150 H:2110mm
 Min Surface Area: 6.05 x 2.88m (17.4m²)
 Min Space: 6.05 x 3.92m FFH: 1.2m



2.4m - 2 Flat Seats

L: 3990 W:1300 H:2510mm
 Min Surface Area: 6.7 x 2.88m (19.3m²)
 Min Space: 6.7 x 3.99m FFH: 1.4m

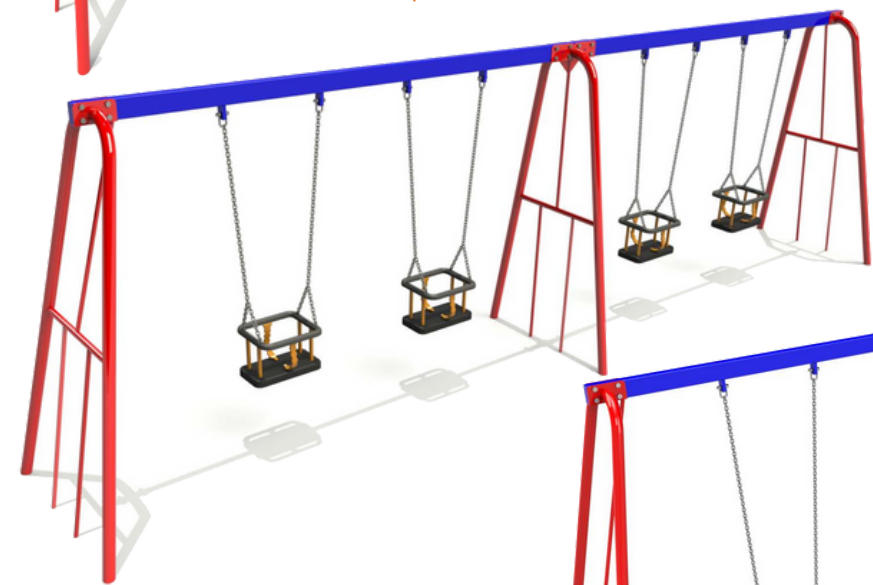

2.0m - 4 Cradle Seats

L: 6980 W:1150 H:2110mm
 Min Surface Area: 6.05 x 5.76m (34.8m²)
 Min Space: 6.98 x 6.05m FFH: 1.2m

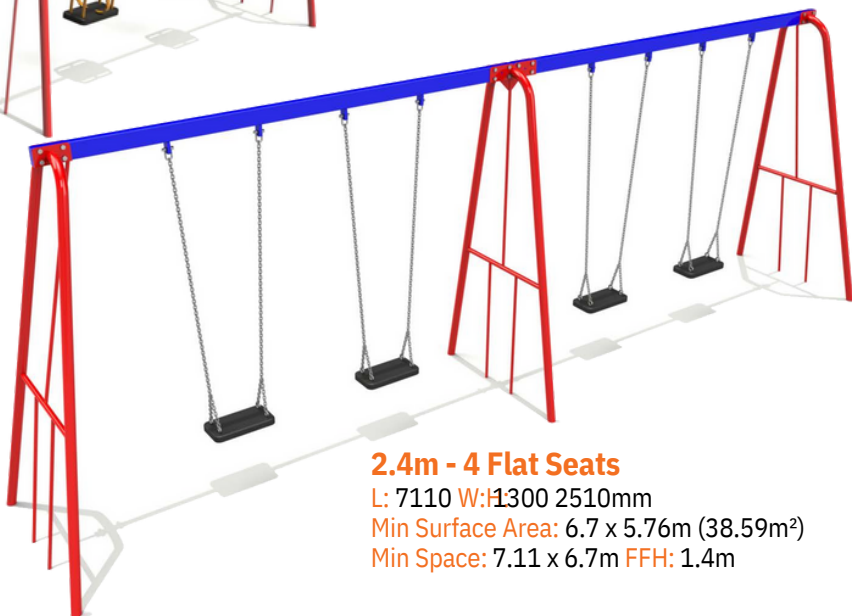

2.4m - 4 Flat Seats

L: 7110 W:1300 H:2510mm
 Min Surface Area: 6.7 x 5.76m (38.59m²)
 Min Space: 7.11 x 6.7m FFH: 1.4m

Other steel colours are available upon request

2.4m - 1 Flat & 1 Cradle Seat

L: 4880 W:1300 H:2510mm
 Min Surface Area: 6.7 x 3.5m (23.45m²)
 Min Space: 6.7 x 4.87m FFH: 1.4m



2.4m - 2 Flat & 1 Cradle Seats

L: 5980 W:1300 H:2510mm
 Min Surface Area: 6.7 x 4.63m (31.02m²)
 Min Space: 6.7 x 5.98m FFH: 1.4m



2.4m - 2 Flat & 2 Cradle Seats

L: 7110 W:1300 H:2510mm
 Min Surface Area: 6.7 x 5.76m (38.59m²)
 Min Space: 7.11 x 6.7m FFH: 1.4m



Steel Swing Frames available without seats and chains.

Frames come with all fixings and swing seat hangers. Universal joints and safety chains are not included with the group seat frames.

Other steel colours are available upon request



2.4m - 2 Flat & 1 Group Seat
 L: 7110 W:1300 H:2510mm
 Min Surface Area: 7 x 5.88m (41.16m²)
 Min Space: 7.2 x 7m FFH: 1.4m

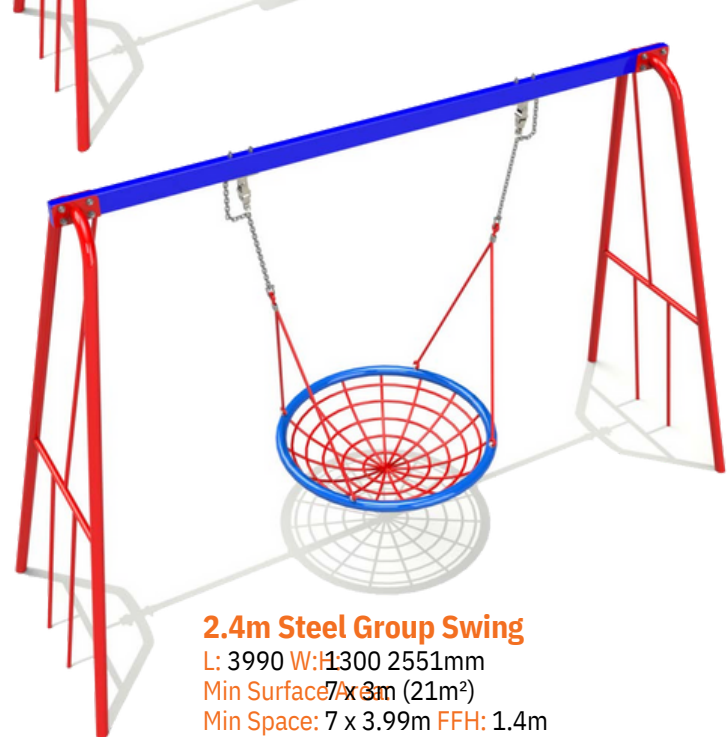

2.4m Steel Group Swing
 L: 3990 W:1300 H:2551mm
 Min Surface Area: 7 x 3m (21m²)
 Min Space: 7 x 3.99m FFH: 1.4m



2.4m - 1 Inclusive Seat
 L: 2820 W:1300 H:2510mm
 Min Surface Area: 7 x 1.8m (12.6m²)
 Min Space: 7 x 2.82m FFH: 1.4m



2.4m - 1 Inclusive & 1 Cradle Seat
 L: 3930 W:1300 H:2510mm
 Min Surface Area: 7 x 2.88m (20.16m²)
 Min Space: 7 x 3.99m FFH: 1.4m



2.4m - 1 Inclusive & 1 Flat Seat
 L: 3930 W:1300 H:2510mm
 Min Surface Area: 7 x 2.88m (20.16m²)
 Min Space: 7 x 3.99m FFH: 1.4m

Other steel colours are available upon request

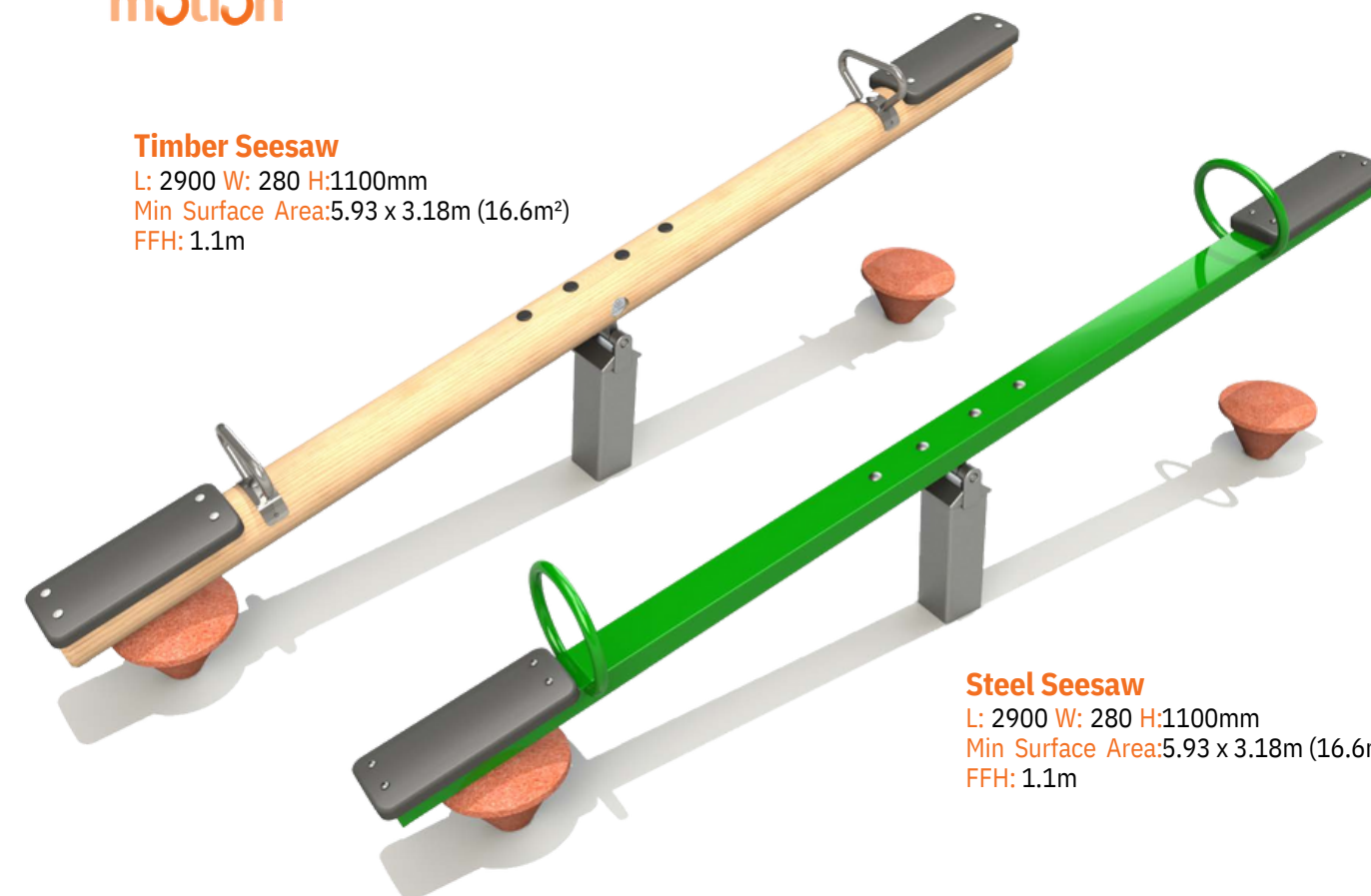

Timber Seesaw
 L: 2900 W: 280 H:1100mm
 Min Surface Area:5.93 x 3.18m (16.6m²)
 FFH: 1.1m

Steel Seesaw
 L: 2900 W: 280 H:1100mm
 Min Surface Area:5.93 x 3.18m (16.6m²)
 FFH: 1.1m

Embankment Slides



Embankment Slides
 Platform Dimensions
 L: 864 W: 614 H: 985mm

Slide Heights
 1m, 1.25m, 1.5m & 2m

Different HDPE colours available on request.

Seesaw units available on request



One Way Timber - 30m

L: 30000 2100 4100mm
 Min Surface Area: 34 x 4m (132m²)
 FF 1.25m

One Way Timber - 25m

L: 25000 2100 4100mm
 Min Surface Area: 29 x 4m (112m²)
 FF 1.25m

One Way Timber - 20m

L: 20000 2100 4100mm
 Min Surface Area: 24 x 4m (92m²)
 FF 1.25m

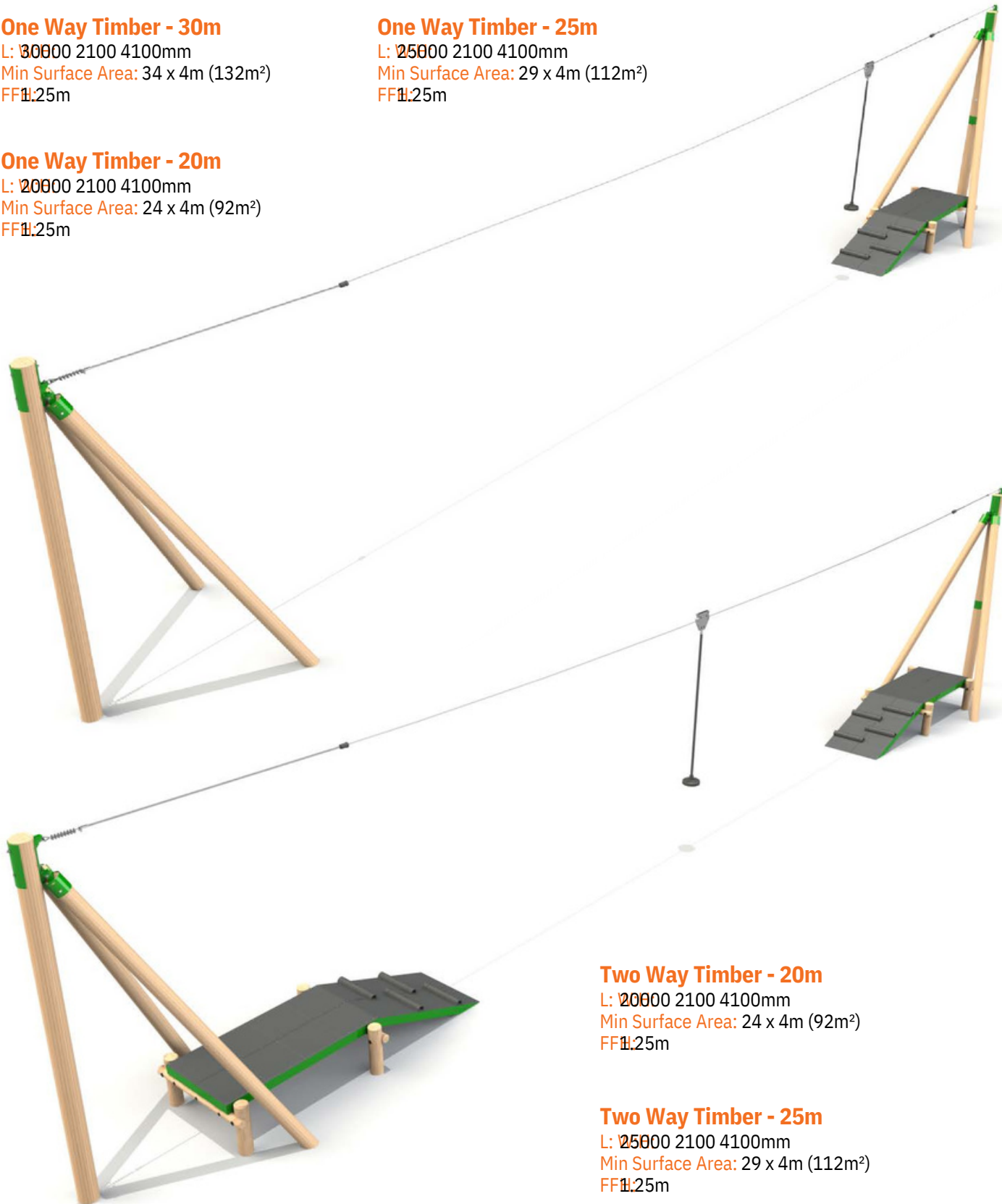

Two Way Timber - 20m

L: 20000 2100 4100mm
 Min Surface Area: 24 x 4m (92m²)
 FF 1.25m

Two Way Timber - 25m

L: 25000 2100 4100mm
 Min Surface Area: 29 x 4m (112m²)
 FF 1.25m



One Way Steel - 25m

L: 25000 2100 3550mm
 Min Surface Area: 29 x 4m (112m²)
 FF 1.25m

One Way Steel - 30m

L: 30000 2100 3550mm
 Min Surface Area: 34 x 4m (132m²)
 FF 1.25m

One Way Steel - 20m

L: 20000 2100 3550mm
 Min Surface Area: 24 x 4m (92m²)
 FF 1.25m

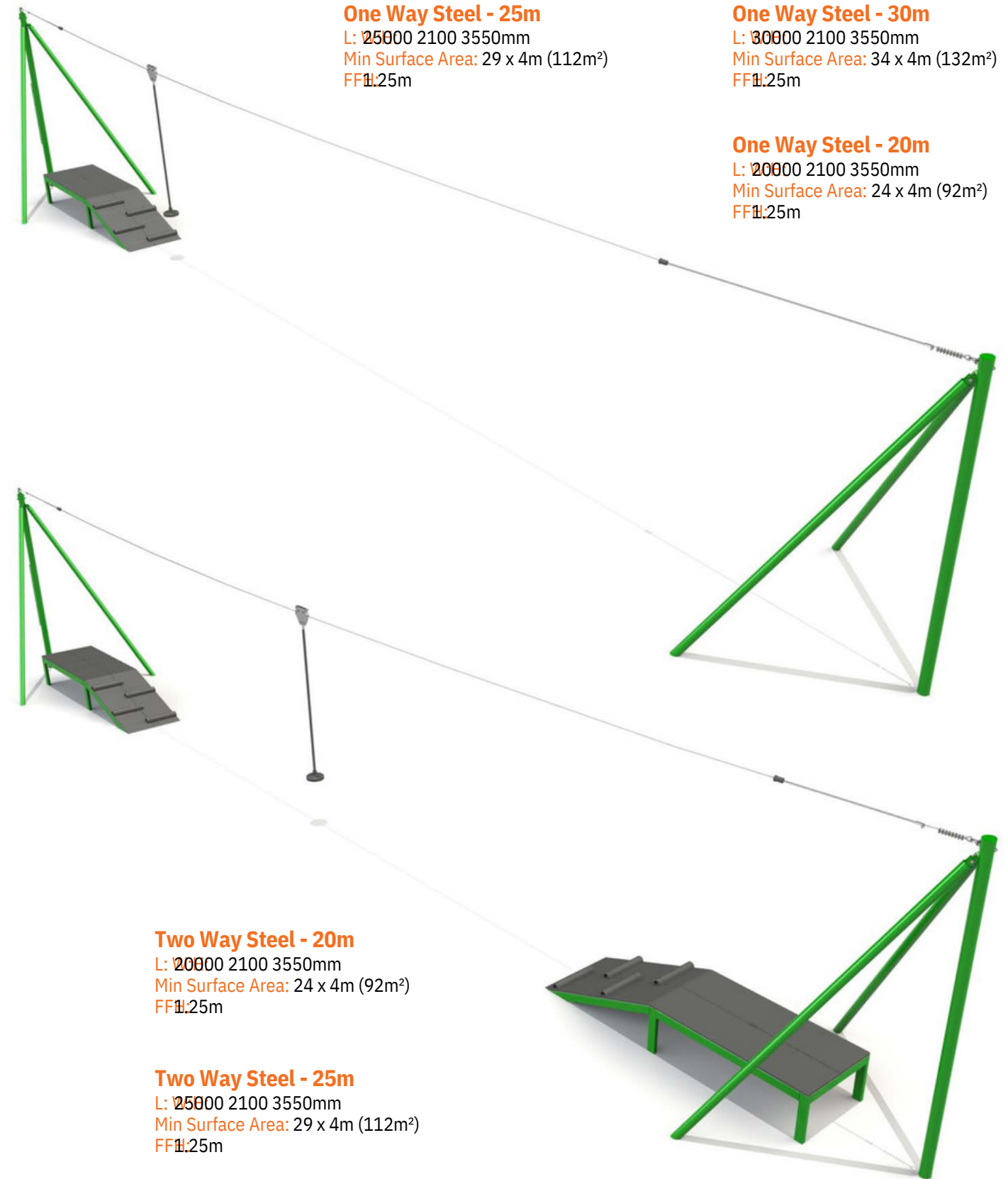

Two Way Steel - 20m

L: 20000 2100 3550mm
 Min Surface Area: 24 x 4m (92m²)
 FF 1.25m

Two Way Steel - 25m

L: 25000 2100 3550mm
 Min Surface Area: 29 x 4m (112m²)
 FF 1.25m



Play Equipment and Safety Surface

Contact us:

T: 01568 782241

E: info@activegarden.co.uk

www.activegarden.co.uk

play in
motion

